



D10 Expert™ – Analog and Discrete Outputs

Advanced sensor for use with plastic fiber optics



Features

- Easy-to-set automatic *Expert*-style TEACH options* including static, dynamic, and single-point programming plus manual adjustment for fine-tuning
- 16-bit microcontroller and 12-bit Analog-to-Digital converter for high-performance, low-contrast sensing
- Easy-to-read 4-digit display for TEACH and signal strength readout, plus indicators for a continuous readout of operating status (user configurable)
- Models available with one scalable Analog output (4-20 mA or 0-10V) and one Discrete output (PNP or NPN)
- Four-mode power and speed selection with automatic cross-talk avoidance circuitry
- Selectable OFF-delay options
- Gate input wire can be used to selectively inhibit sensor outputs from switching
- Models available with visible red (680 nm) or visible green (525 nm) sensing beam
- Models available with 2 m or 9 m (6.5' or 30') cable or integral Pico-style quick-disconnect
- Sleek, ultra-slim 10 mm housing, mounts to a standard 35 mm DIN rail

* U.S. Patent #5,808,296

Models

Models		Cables*	Discrete Outputs	Analog Output
Red Beam	Green Beam			
D10INFP	D10INFPG	2 m (6.5') Cable	NPN	4-20 mA
D10INFPQ	D10INFPGQ	6-pin Pico-style QD		
D10IPFP	D10IPFPG	2 m (6.5') Cable	PNP	
D10IPFPQ	D10IPFPGQ	6-pin Pico-style QD		
D10UNFP	D10UNFPG	2 m (6.5') Cable	NPN	0-10V
D10UNFPQ	D10UNFPGQ	6-pin Pico-style QD		
D10UPFP	D10UPFPG	2 m (6.5') Cable	PNP	
D10UPFPQ	D10UPFPGQ	6-pin Pico-style QD		

* 9 m (30') cables are available by adding suffix "W/30" to the model number of any cabled sensor (e.g., D10INFP W/30). A model with a QD connector requires a mating cable (see page 15).



WARNING . . . Not To Be Used for Personnel Protection

Never use these products as sensing devices for personnel protection. Doing so could lead to serious injury or death.

These sensors do NOT include the self-checking redundant circuitry necessary to allow their use in personnel safety applications. A sensor failure or malfunction can cause either an energized or de-energized sensor output condition. Consult your current Banner Safety Products catalog for safety products which meet OSHA, ANSI and IEC standards for personnel protection.

D10 Expert™ Analog and Discrete Outputs

Overview

The D10 Expert Sensor is a high-performance plastic fiber-optic sensor whose many configuration (TEACH-mode) options make it suitable for demanding applications. Even with all its features, it is extremely easy to use. Advanced 16-bit microcontroller technology makes this possible.

The D10 Expert provides high-performance sensing in low-contrast applications. Expert TEACH and setup options provide static, dynamic and single-point programming plus manual fine adjustment, remote programming and push button lockout. Its slender, stylized housing has a large digital display visible beneath a clear cover for easy programming and status monitoring during operation. The sensor mounts directly to standard 35 mm DIN rail or using the supplied mounting bracket.

The sensor features two outputs with independent setpoints: one of two analog choices, depending on model, and one discrete (NPN or PNP, also depending on model). Built-in crosstalk avoidance protocol provides trouble-free operation for multiple sensors in one area.

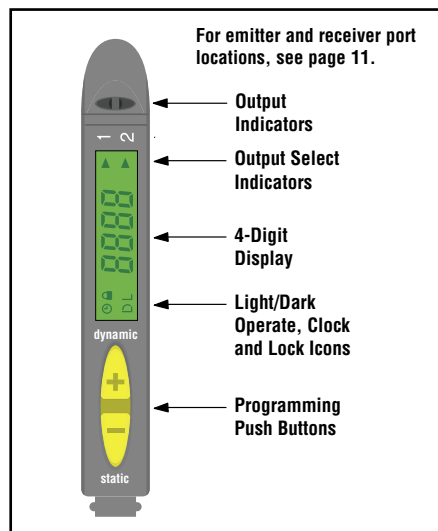

Figure 1. D10 features

Programming Options



Light/Dark Operate Selection	Toggle to select the condition for which each output will conduct: when the target is present or when the target is absent.								
OFF-Delay Timing Selection	Programmable OFF-delay pulse stretcher: 0, 2, 5, 10, 15, 20, 30, 40, 60, 80, or 100 milliseconds Analog Outputs: OFF-delay acts as a smoothing function								
Display Selection	Discrete Output: Raw signal value or % excess signal Analog Output: Raw signal value or analog value (0-10V dc or 4-20 mA)								
Power Level/Speed Selection	Super High-Speed (SHS)		High-Speed (HS)		High-Power (HP)		Super High-Power (SHP)		
Response*	50 µs		200 µs		1 ms		2.5 ms		
Repeatability	25 µs		50 µs		75 µs		100 µs		
Maximum Range*	Fiber	Red 680 nm	Green 525 nm	Red 680 nm	Green 525 nm	Red 680 nm	Green 525 nm	Red 680 nm	Green 525 nm
	PIT16U	20 mm	9 mm	30 mm	9 mm	55 mm	13 mm	90 mm	16 mm
	PIT26U	100 mm	40 mm	150 mm	40 mm	250 mm	55 mm	400 mm	70 mm
	PIT46U	300 mm	100 mm	550 mm	100 mm	1000 mm	160 mm	1200 mm	180 mm
	PIT66U	600 mm	180 mm	1000 mm	180 mm	1700 mm	280 mm	2400 mm	320 mm
	PBT16U	6 mm	**	10 mm	**	18 mm	3 mm	30 mm	3.5 mm
	PBT26U	30 mm	12 mm	50 mm	12 mm	100 mm	20 mm	150 mm	25 mm
	PBT46U	100 mm	30 mm	175 mm	30 mm	250 mm	42 mm	300 mm	60 mm
PBT66U	175 mm	55 mm	250 mm	55 mm	400 mm	80 mm	475 mm	100 mm	
Tracking Feature	Sets Output 2 to identical settings as Output 1; Output 2 settings can then be revised as desired. (See Advanced Setup procedure, page 11.)								
Factory Default Settings	The following settings are preset at the factory; revert sensor to factory defaults using Advanced Setup procedure (page 11). <ul style="list-style-type: none"> • Light operate (L) • No OFF-delay (t 0) • Raw signal value (1234) • Output 1 displayed • High Speed (HS); 200 µs response • Maximum power setting • Analog: full scale • Discrete: switchpoint positioned at middle of range 								

* Diffuse mode performance based on 90% reflectance white test card.

** ø0.010" bifurcated fiber not recommended in these speed settings. Contact Banner Applications for more information.

D10 Expert™ Analog and Discrete Outputs

Specifications

Required Fiber-Optic Cable	Banner P-Series plastic fibers		
Sensing Beam	Visible red, 680 nm, or Visible green, 525 nm, depending on model		
Supply Voltage and Current	4-20 mA Analog Models: 12 to 24V dc (10% maximum ripple) at less than 65 mA, exclusive of load 0-10V dc Analog Models: 15 to 24V dc (10% maximum ripple) at less than 70 mA, exclusive of load		
Supply Protection Circuitry	Protected against reverse polarity and transient voltage		
Output Configuration	2 independently configurable outputs, depending on model: NPN w/analog (4-20 mA or 0-10V) or PNP w/analog (4-20 mA or 0-10V)		
Output Rating	Discrete Output: 150 mA, max. load OFF-state leakage current: < 10 µA at 24V dc ON-state saturation voltage: NPN < 1.5V dc at 150 mA PNP < 2.5V dc at 150 mA	Analog Output: 4-20 mA or 0-10V dc Load: 4-20 mA Models: 100Ω max. impedance 0-10V dc Models: 1 MΩ min. impedance	
Output Protection Circuitry	Protected against false pulse on power-up and continuous short-circuit		
Output Response Time	Discrete Output: Programmable, 50 microseconds, 200 microseconds, 1 millisecond, 2.5 milliseconds Analog Output: 1 millisecond NOTE: < 1 second delay on power-up; outputs do not conduct during this time.		
Adjustments	Push-button or remote programming of response time, OFF-delay, light/dark operate, and display		
Indicators	Four-digit digital display plus LED indicators for active channel, push-button lockout, OFF-delay and light/dark operate selection; 2 yellow output indicators		
Construction	Black ABS/polycarbonate alloy (UL94 V-0 rated) housing, clear polycarbonate cover		
Environmental Rating	NEMA 1, IEC IP50		
Connections	PVC-jacketed 2 m or 9 m (6.5' or 30') 6-wire integral cable or integral 6-pin Pico-style quick-disconnect		
Operating Conditions	Temperature: -20° to +55°C (-4° to +131°F) Storage Temperature: -20° to +80°C (-4° to +175°F) Max. Rel. Humidity: 90% @ 50°C (non-condensing)		
	Number of Devices, Stacked	Ambient Temperature Rating	Load Specification
	3	55°C	150 mA
	7	50°C	50 mA
10	45°C	50 mA	
Installation	35 mm DIN rail or included mounting bracket		
Certifications	 		

D10 Expert™ Analog and Discrete Outputs

Dimensions

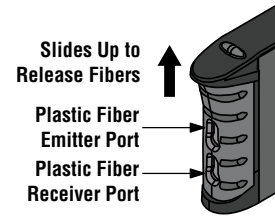
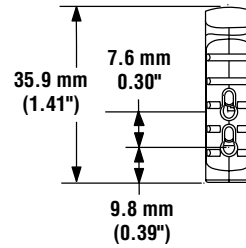
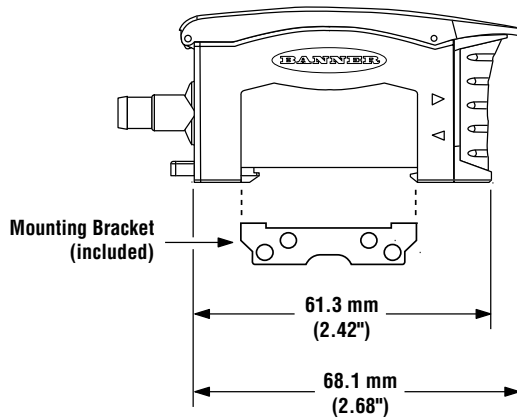
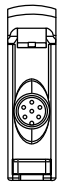
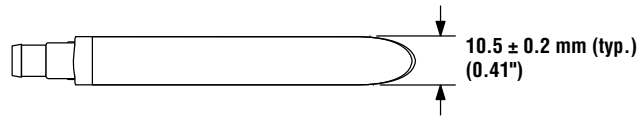

Included Bracket Dimensions

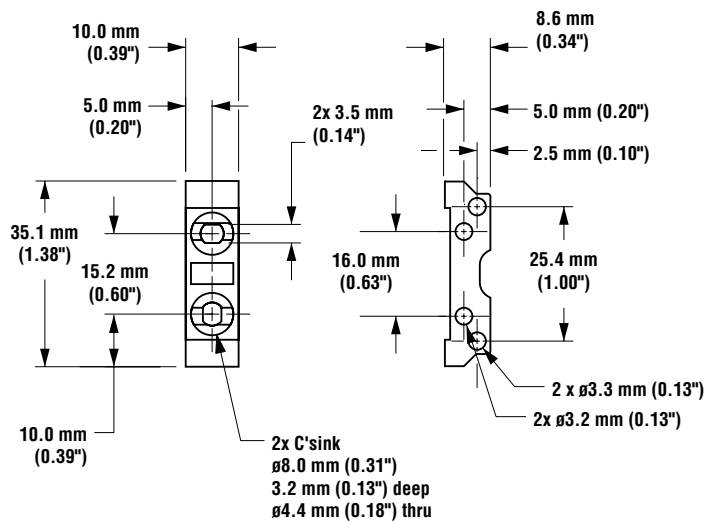

- M3 Hardware included:
- Lock Washer (2)
 - Flat Washer (2)
 - Screws (2)
 - Hex Nuts (2)